

NOTE: It is recommended that two persons assemble this unit.

ASSEMBLY INSTRUCTIONS

PARTS LISTS

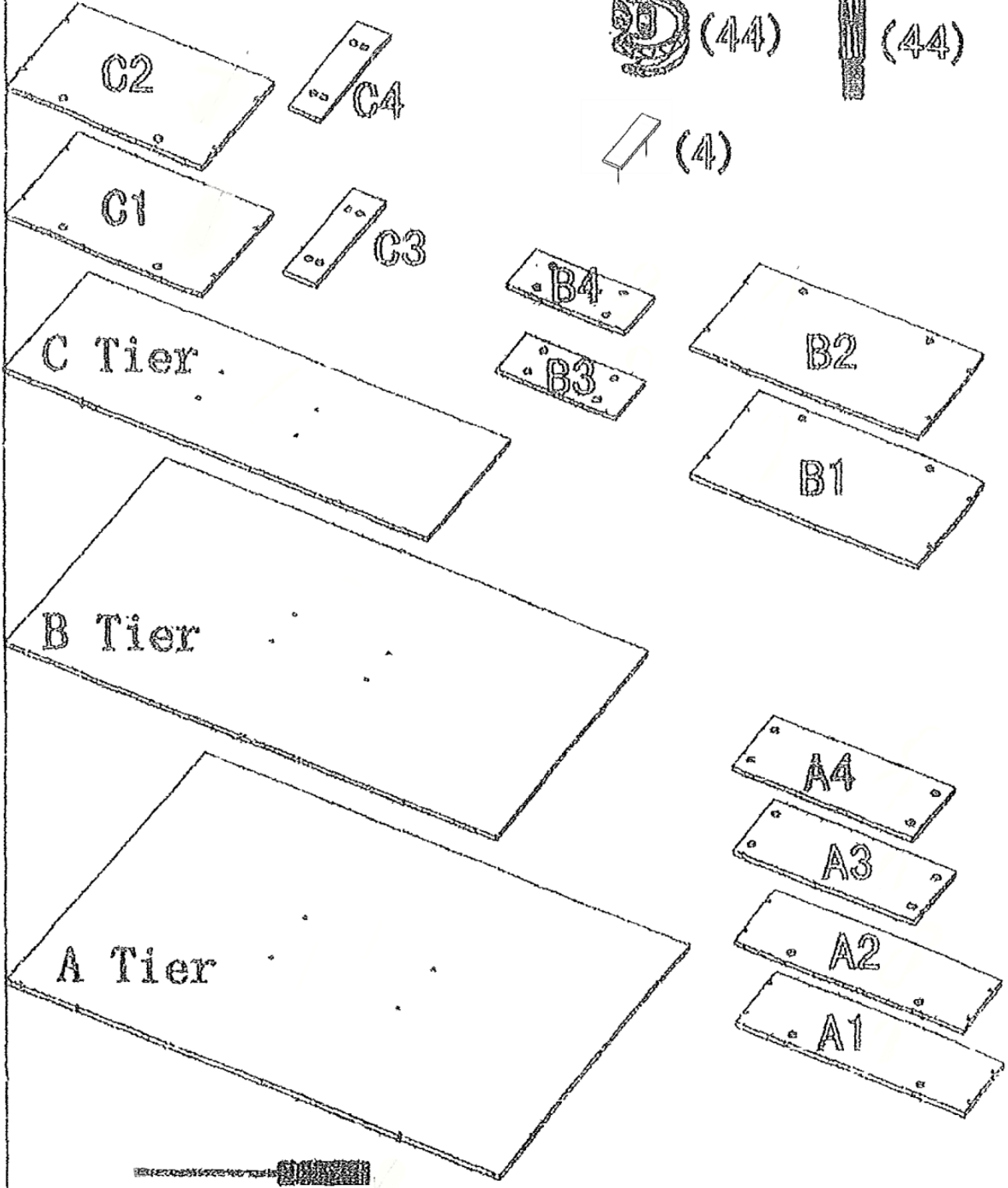

TOOLS REQUIRED

1

(20)

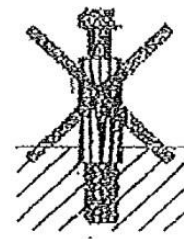
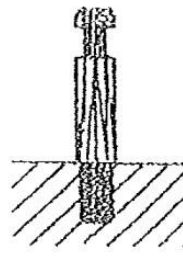
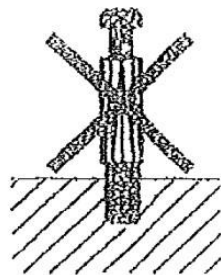
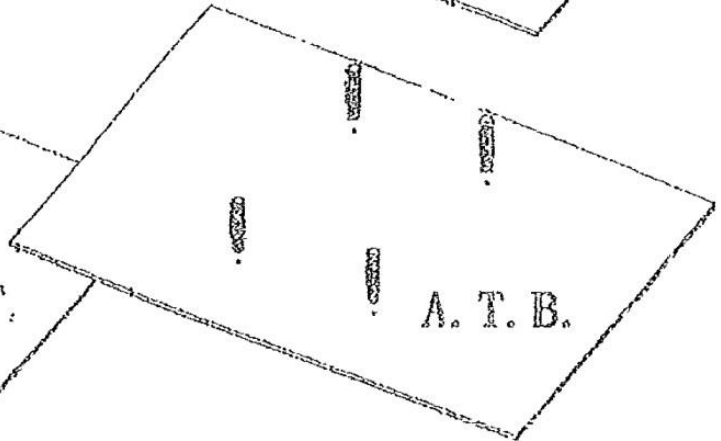
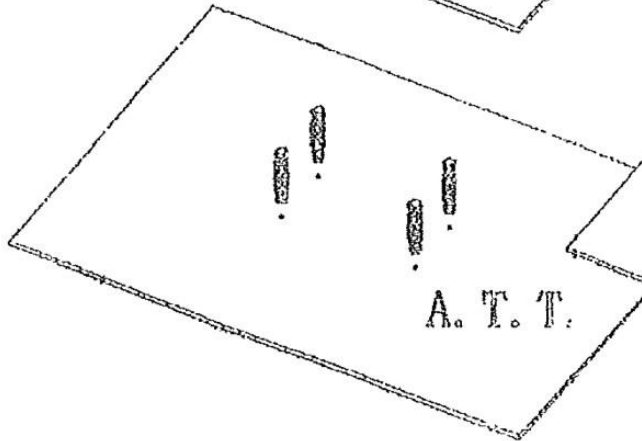
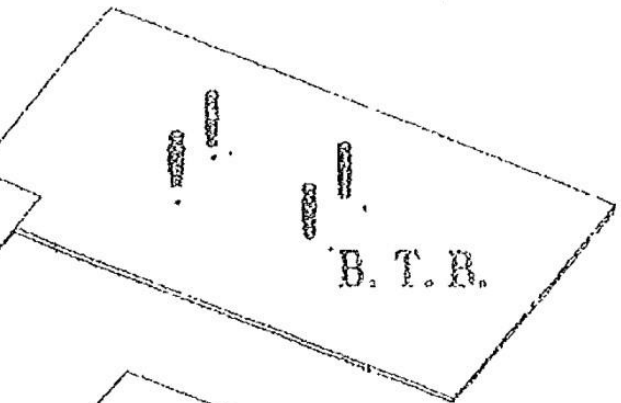
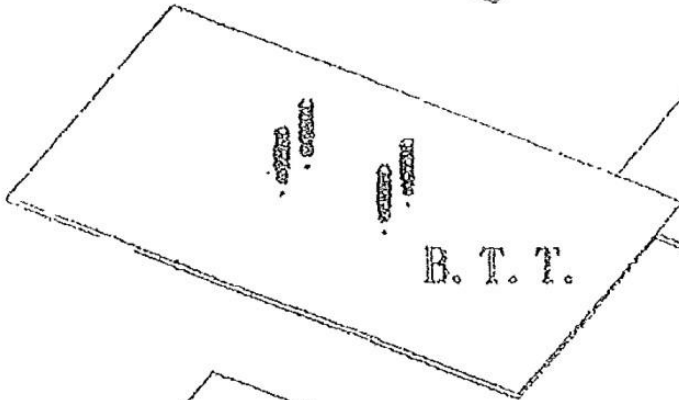
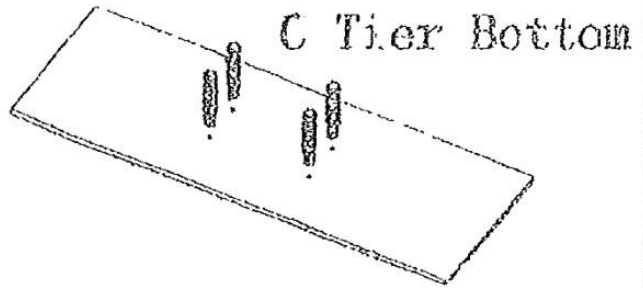

2

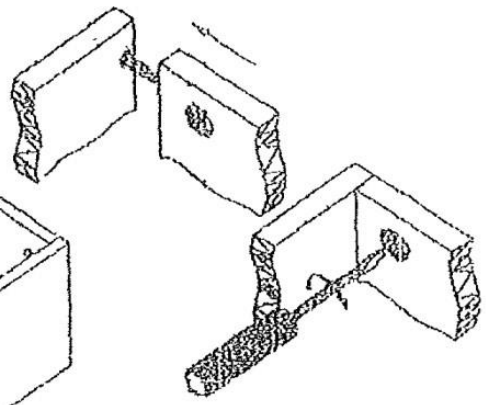
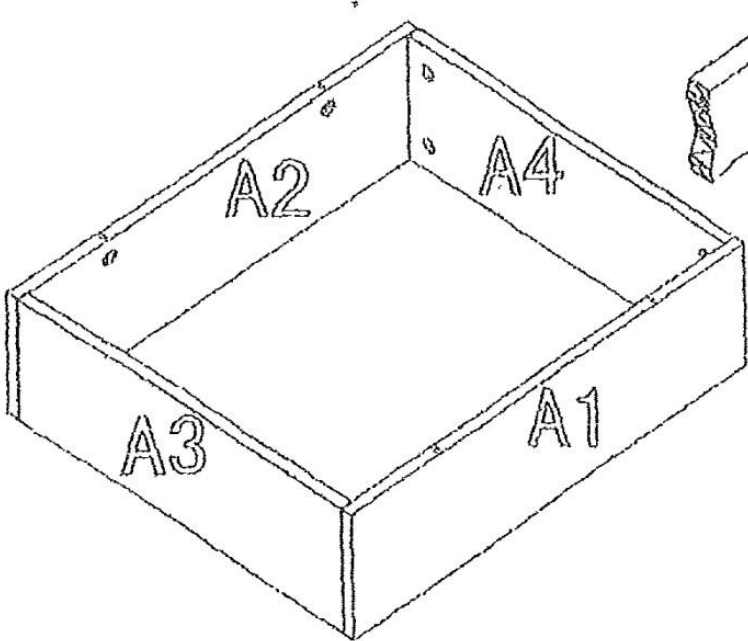
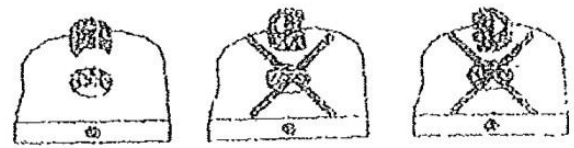
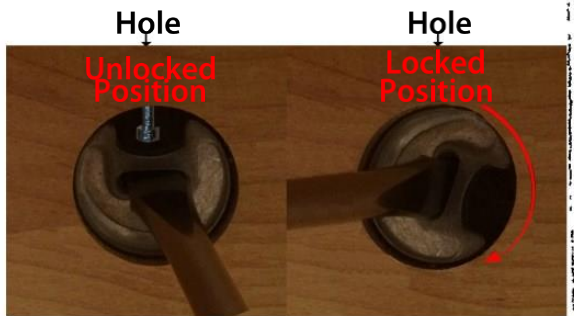
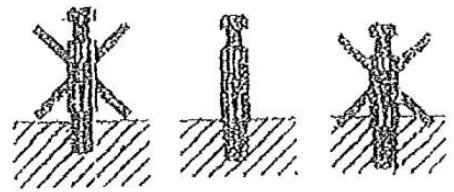
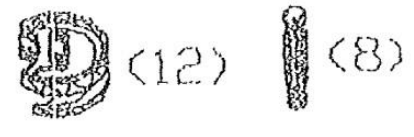
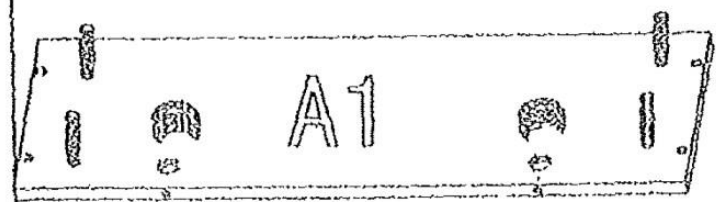
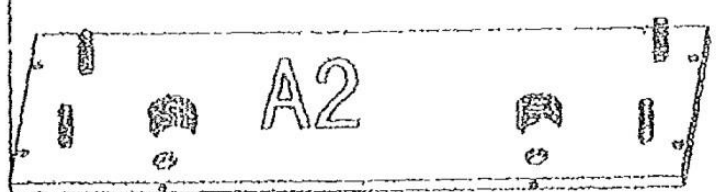
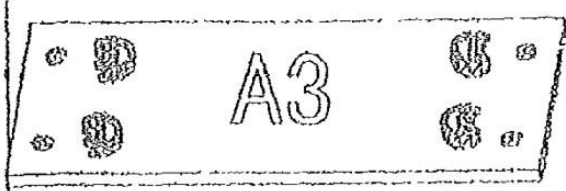
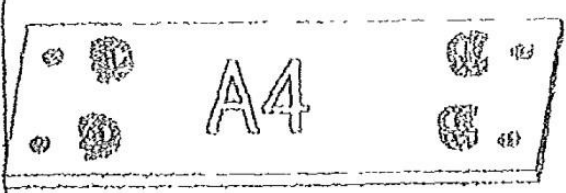

BASE A ASSEMBLED

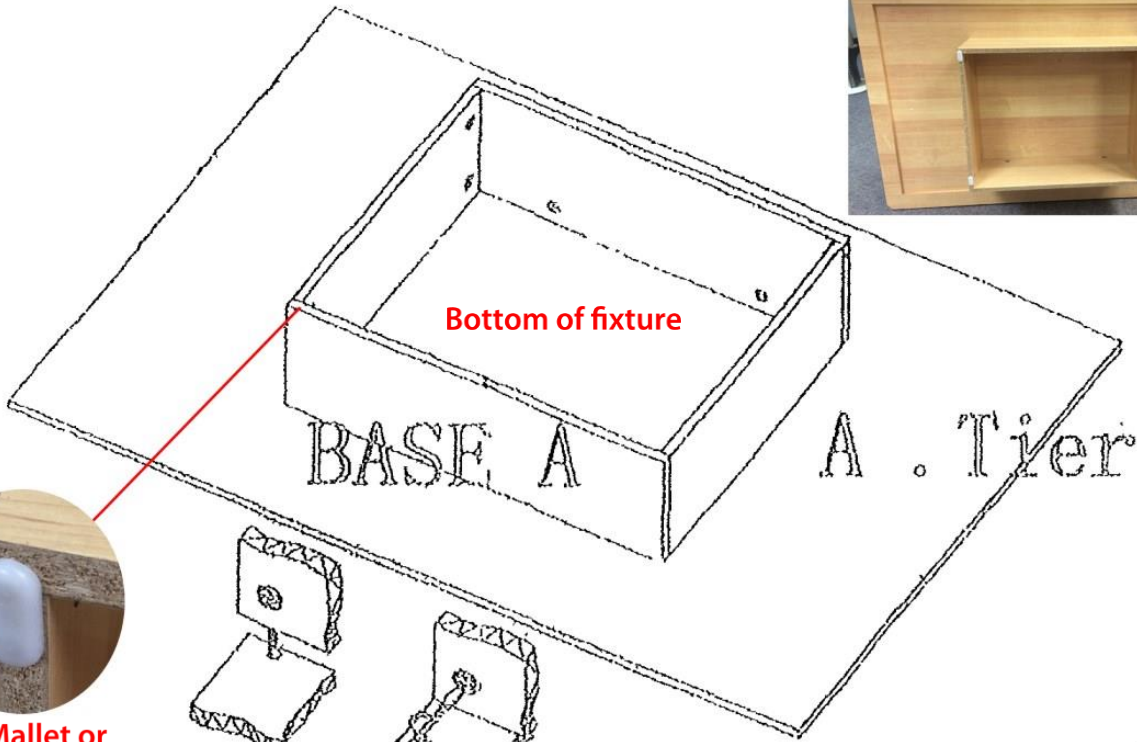

Use Mallet or hammer to tap the glides in each corner

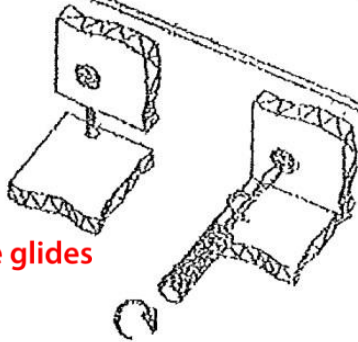

4

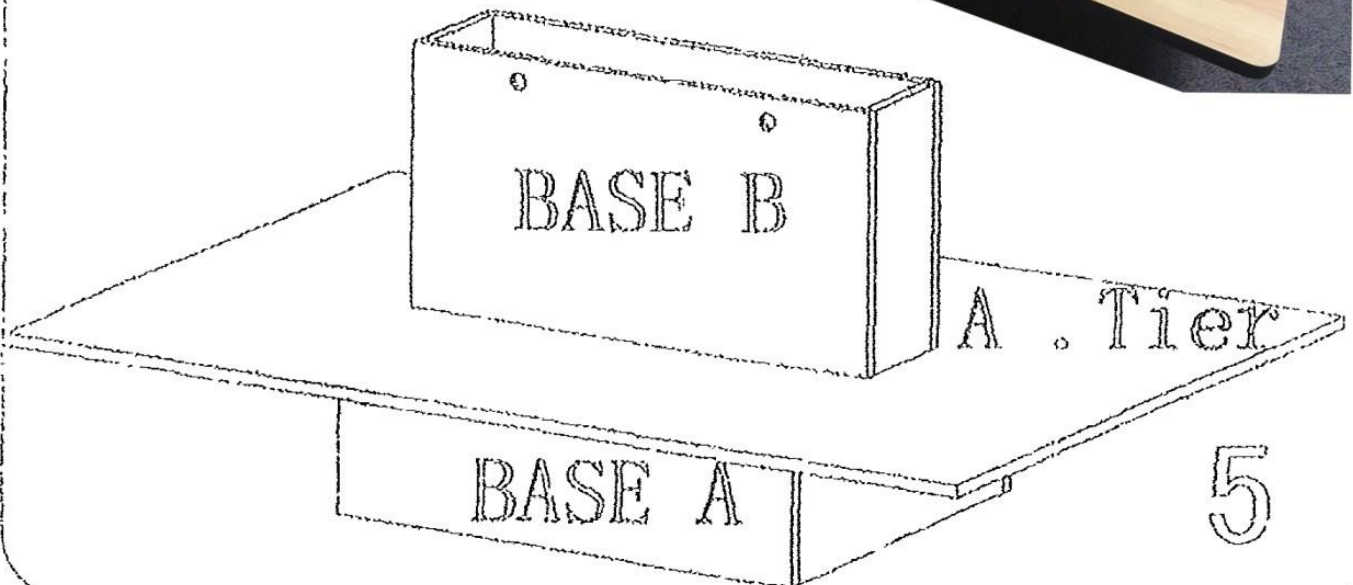

5

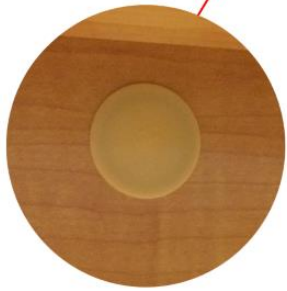
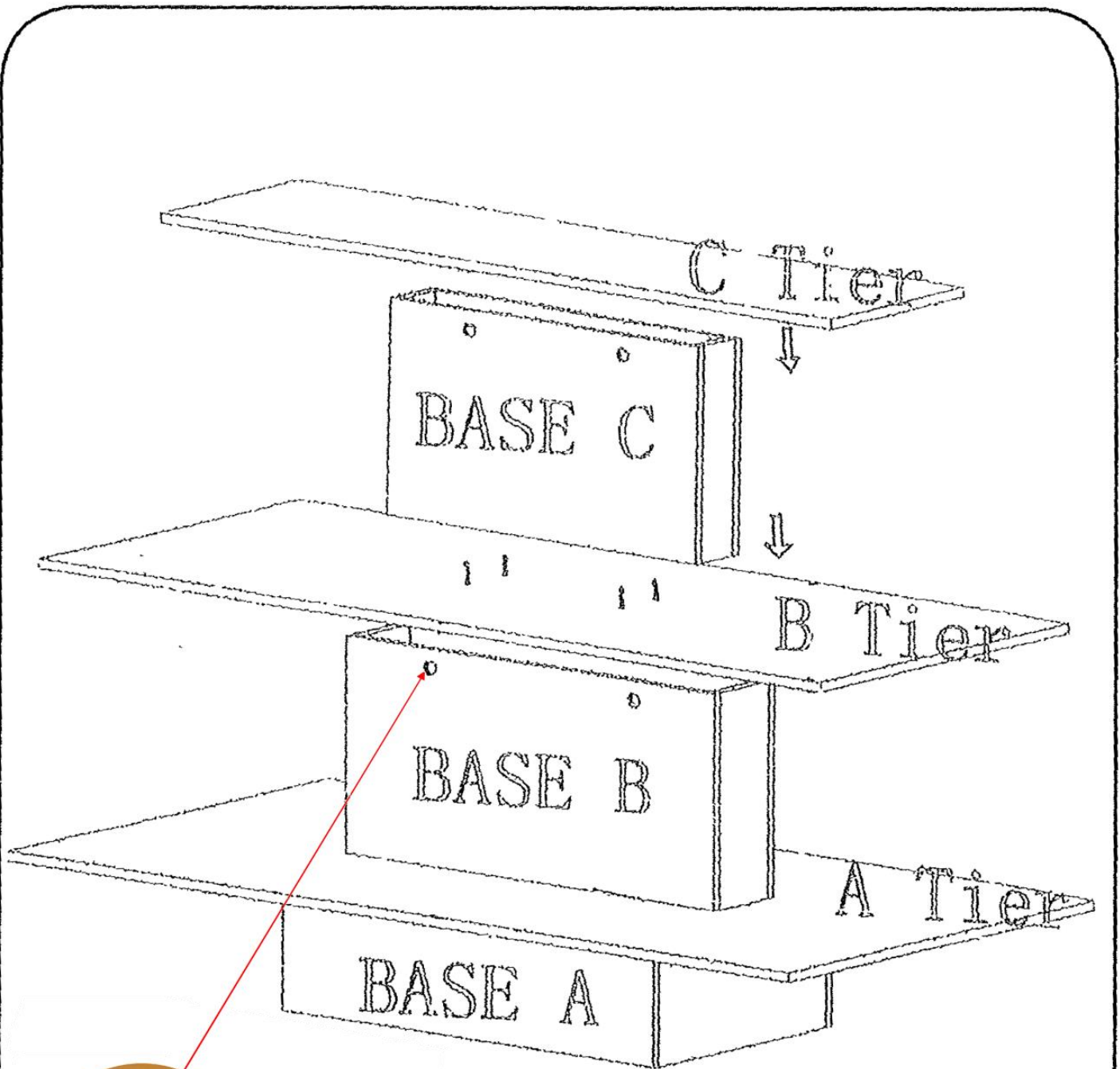

Fill exposed holes
with supplied covers.

